

EINSCHUBKORPUS

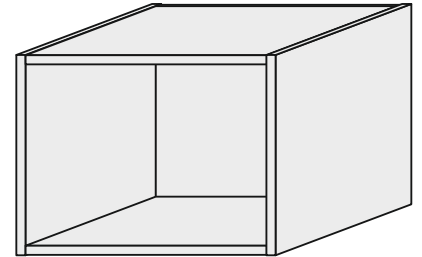

- | | |
|---|-------------------------------------|
| (D) Montageanleitung | (GB) Assembly instructions |
| (FR) Notice de montage | (IT) Istruzioni di montaggio |
| (NL) Handleiding voor de montage | (PL) Instrukcja montażu |
| (CZ) Montážní návod | (SK) Návod na montáž |
| (HU) Szerelési útmutató | (RO) Instrucțiuni de montare |
| (TR) Montaj talimati | (RU) инструкции по монтажу |

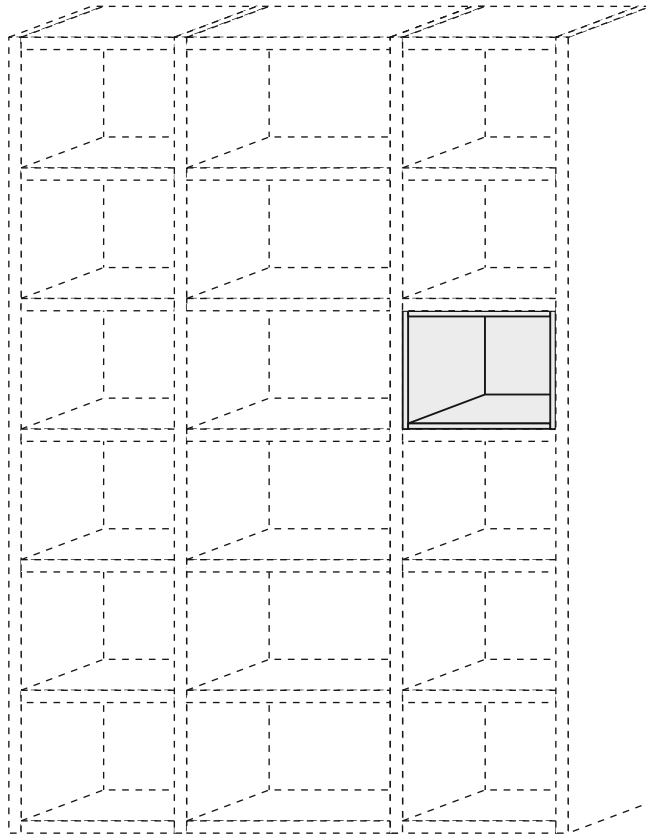
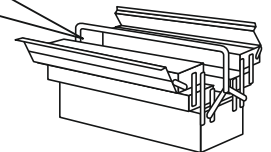
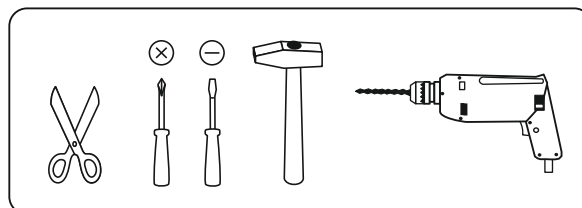
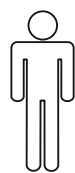

Service - Assistenza - Dienstverlening - Serwis Servis Szerviz - Servicii - статистическая служба

Name • Nom • Nome • Naam
Nazwa • Jméno • Názov • Név
Denumire • Isim • название

Nr. • No. • N° • номеро • Č • Sz

Typ • Type • Tip • Típus • Tipo • тип

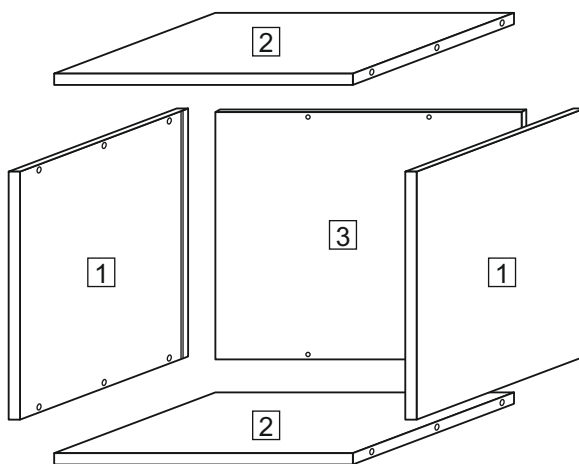
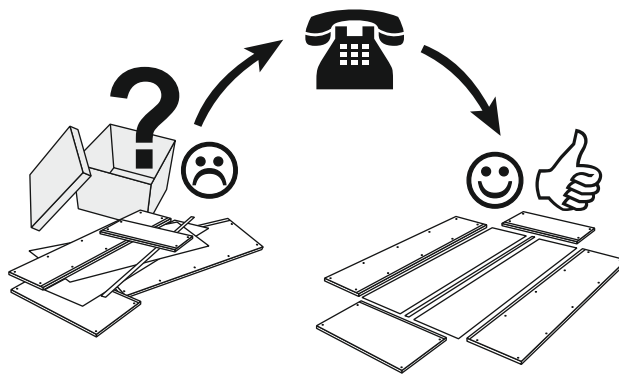
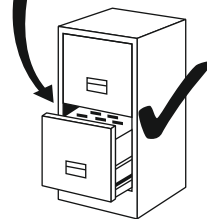
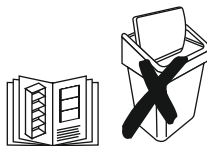

1 2 x 328 x 330 x 12

2 2 x 395 x 316 x 12

3 1 x 405 x 327 x 2,8

01-4358



6 x 30

12

01-9201



1

01-2506



3,0 x 20

4

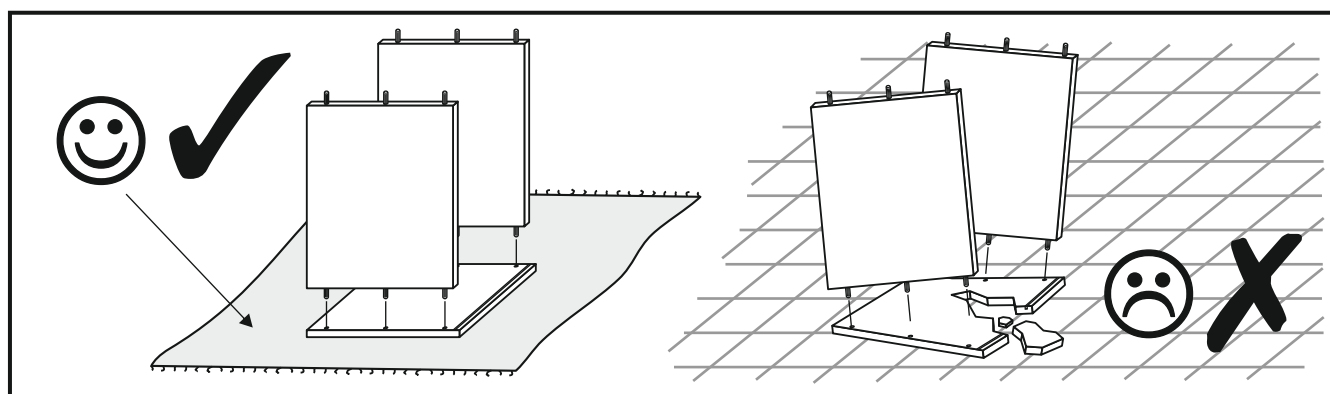

D	Bitte nur mit einem Staubtuch oder leicht feuchtem Lappen reinigen. Keine scheuernden Putzmittel verwenden.	CZ	Čistěte prosím jen prachovkou nebo lehce navlhčeným hadrem. Nepoužívejte drhňoucí čističí prostředky.
GB	Please only clean with a duster or a damp cloth. Do not use any abrasive cleaners.	SK	Na čistenie používajte len prachovku alebo zľahka navlhčenú utierku. Nepoužívajte žiadne drhňúce čistiace prostriedky.
FR	Veillez nettoyer uniquement avec un chiffon à poussière ou un chiffon légèrement humide. Ne pas utiliser de détergent abrasif.	HU	Kérjük, csak portörölő kendővel vagy enyhén nedves ronggyal tisztítsa. Ne használjon dörzshatású tisztítószert.
IT	Si raccomanda di pulire solo con un panno per la polvere o uno strofinaccio umido. Non utilizzare detergenti abrasivi.	RO	Vă rugăm să utilizați la curățare exclusiv o cârpă de șters praful sau o cârpă ușor umezită. Nu utilizați substanțe de curățat abrazive.
NL	Reinig alleen met een stofdoek of een lichtjes vochtige doek. Gebruik geen schurende poetsmiddelen.	TR	Lütfen sadece bir toz bezikle veya hafif nemli yumuşak bir bezle siliniz. Aşındırıcı temizlik malzemeleri kullanmayınız.
PL	Czyszczenie należy wykonać wyłącznie za pomocą ściereczki lub lekko nawilżonego ręcznika. Nie stosować środków czyszczących do szorowania.	RU	Очищайте от пыли тряпкой или слегка влажной ветошью. Не допускается применение чистящих средств, не предназначенных для ухода за мебелью.

1

01-4358

6 x 30
12

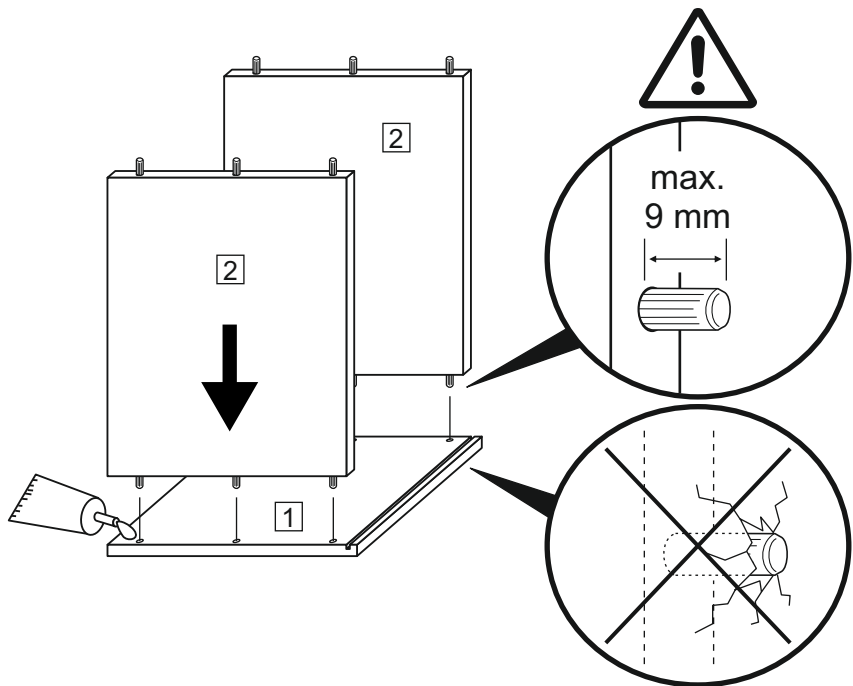
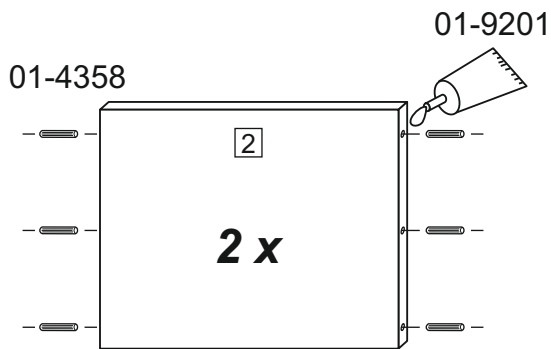
01-9201

1



2

01-9201

1

